

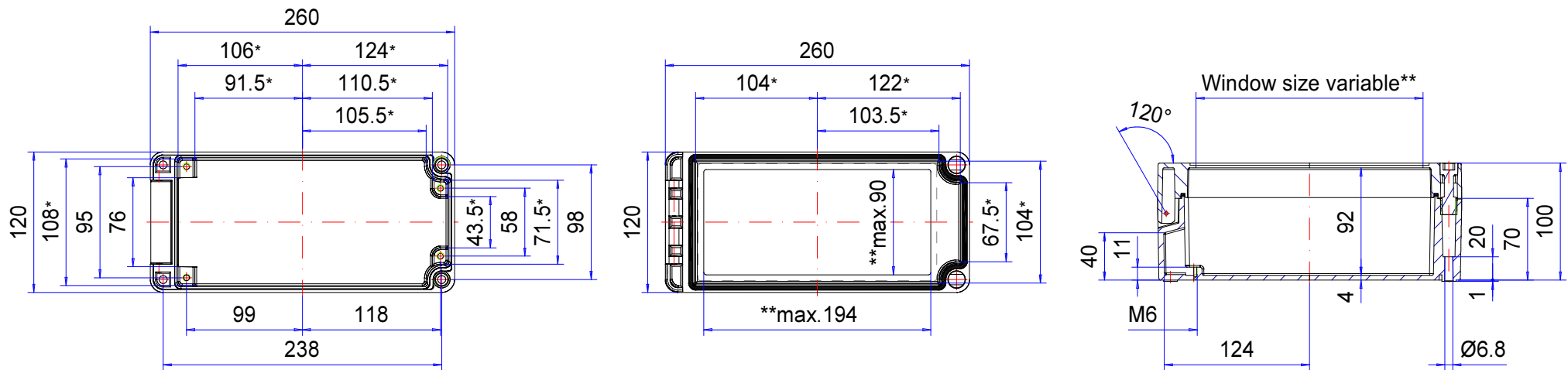

# Enclosure series polyDOOR

Type: PD 124 FE

Material-No.: 131.124.000



\* Please note: Mould slope for casting ejection, dimensions in the amount of the bottom!

Enclosure material	Polyester GrP, UL 94 V-0, RAL 7032, pebble grey		Ingress protection	IP66 EN 60529
Lid screws	2x Polyamide (PA), captive		Weight	1.250 g
Gasket	1x EPDM		Tolerance	DIN ISO 16901 T-130 (outside dimensions ±0,5mm)

technical changes subjected