

Enclosure series aluDOOR

Type: ADF 112

Material-No.: 133.112.000

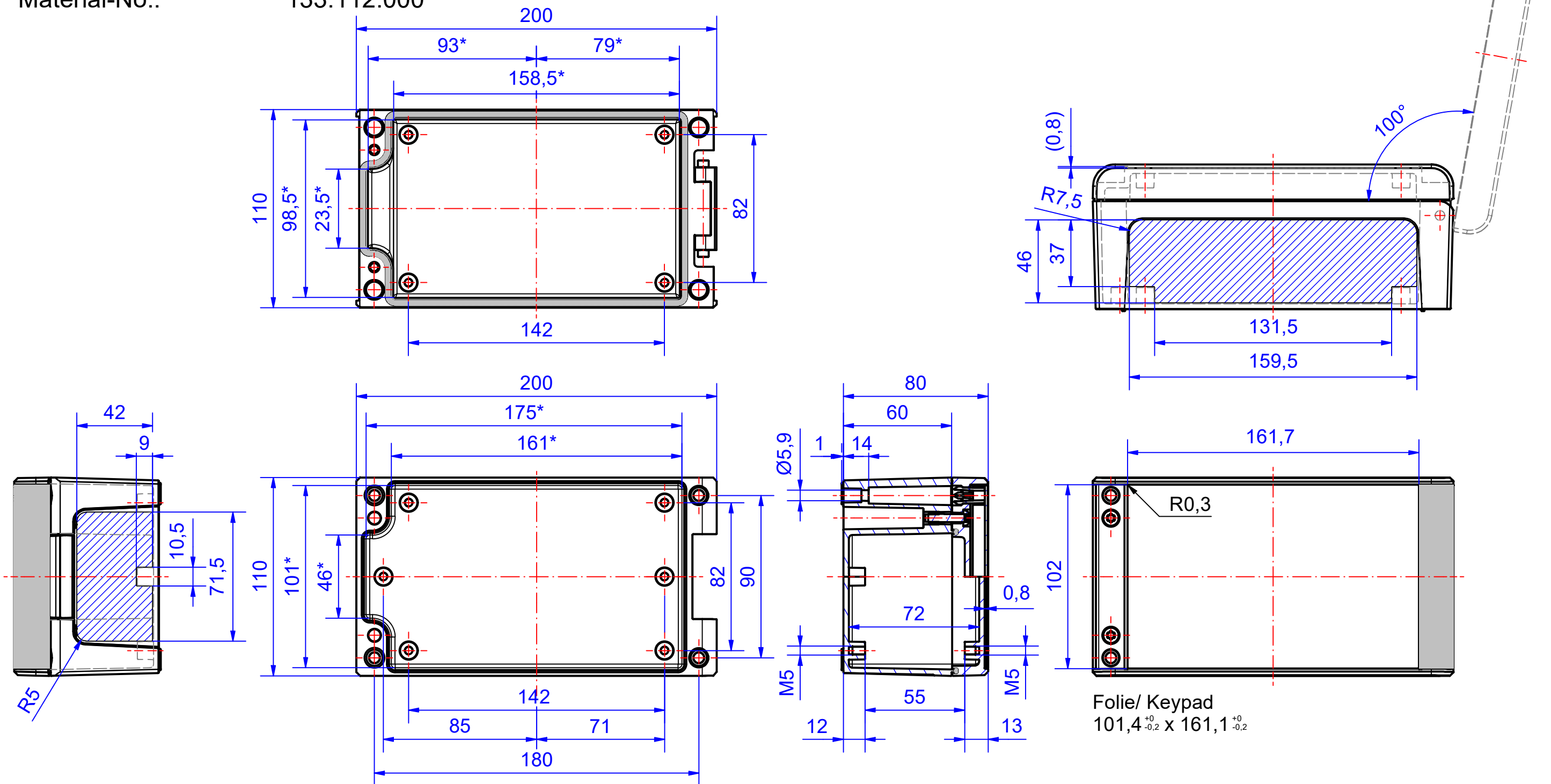

\* Please note: Enclosure with draft angles, dimensions in the amount of the bottom!

Enclosure material	EN-AC-AI Si 12 (DIN 1725)		Ingress protection	IP66/67 EN 60529, IP69K ISO 20653
Lid screws	1.4567, M5, Tx25,captive		Weight	975 g
Assembly screws	5x M5x8, Tx25, V2A		Coating	Powder coating RAL 7016, anthracite grey mat
Design covers	Powder coating, silver mat		Tolerance	DIN EN ISO 8062-3:2008-09 DCTG4 (outside dimensions ±0,5mm)
Gasket	Dosed, PUR			